

HEATSCOPE®

ROOMS | TUNE

**Technical
documentation**





Contents

HEATSCOPE TUNE - Introduction and information	4-7
Dimensions, towel rails and versions	8-9
HEATSCOPE TUNE product overview	13
Connection types and technical data sheets	17
- Connection types for the HEATSCOPE TUNE	18
- Data sheets for HEATSCOPE TUNE vertical	19
- Data sheets for HEATSCOPE TUNE vertical towel rails	26
- Data sheets for HEATSCOPE TUNE horizontal	28
HEATSCOPE TUNE Music Interface	30
- Connection to the HEATSCOPE TUNE Music Interface	31
HEATSCOPE TUNE operating instructions	32
- Functions	33
- Initial use	34
- Setting the day and time	35
- Adjusting the brightness, general switch-on and switch-off	36
- Programming a week	37-39
- Starting the on-demand timer in two steps	40
HEATSCOPE TUNE installation instructions	42
- Installation and mounting guidelines	42-43
- Warranty / scope of delivery	44-45
- Installation instructions for wall or ceiling mounting; guide to symbols	46

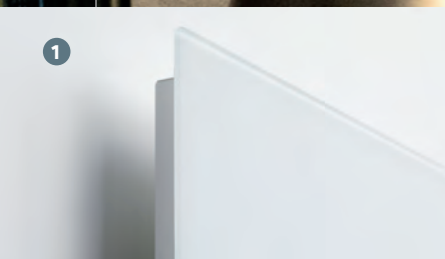

1



2

- 1 Small installation depth
- 2 Towel rail V with magnetic mounting

The HEATSCOPE TUNE sets the tone with simple elegance. The immaculate design blends into the architecture perfectly and is sure to catch the eye of purists and aesthetes alike. Functionality and finesse lie in the many details that underpin the impressive visual appeal. Enhance your bathroom with a beautiful treat for yourself and your towels.



UP TO
75%*
ENERGY
SAVING

* Compared to conventional electric heated towel rails.

You can choose vertical or horizontal installation, depending on the model. The HEATSCOPE TUNE is always elegant, unobtrusive and functional. The glass front is easy to clean. The small installation depth doesn't take up any unnecessary space, and the simple towel rail is height-adjustable on the vertical version. The HEATSCOPE TUNE sits gently against the wall, blends in seamlessly and is impressively effective.

10
YEAR
warranty

HEATSCOPE® TUNE vertical

The white and unassuming exterior conceals a unique centre of technology. Your finger is the key to unlock a whole menu of options on the HEATSCOPE TUNE.

NEW

Musik via Bluetooth

The optional Music Interface can play your favourite songs from your smartphone, iPad, etc. – with incredible sound quality. The music is invisibly integrated into the HEATSCOPE TUNE.

- 1 Electronic control panel with touch function
- 2 Integrated temperature selection and on-demand timer for ad hoc use, as well as a weekly timer
- 3 LED display in operating mode

1



2



3



HEATSCOPE®
TUNE vertical

Dimensions, towel rails
and versions



Matt white surface

Matt black surface



Towel rail V
(chrome or stainless steel look)

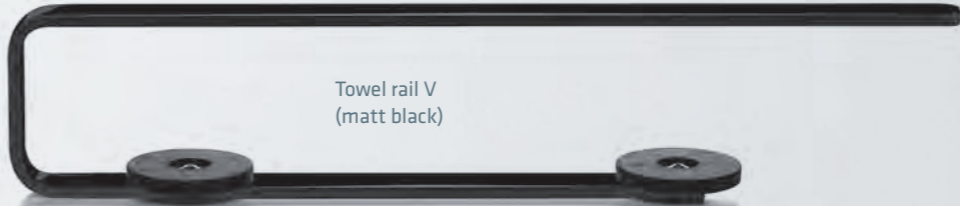

Towel rail V
(matt black)

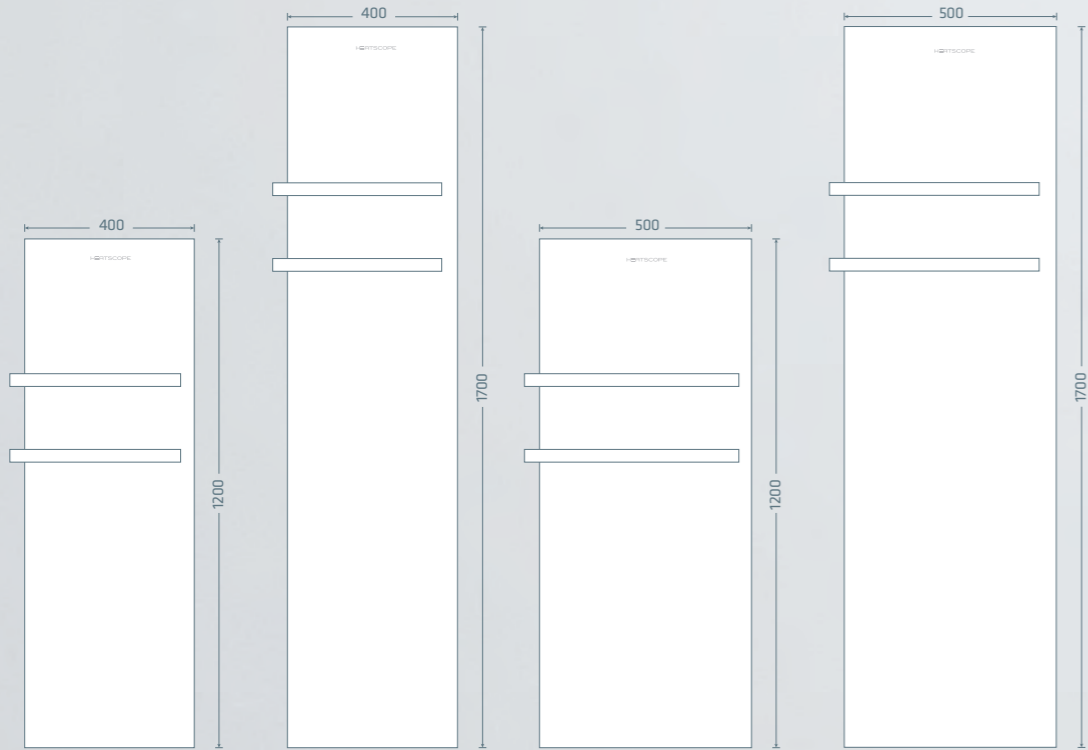

Model	Power
40-360	360 W
40-530	530 W
50-460	460 W
50-720	720 W

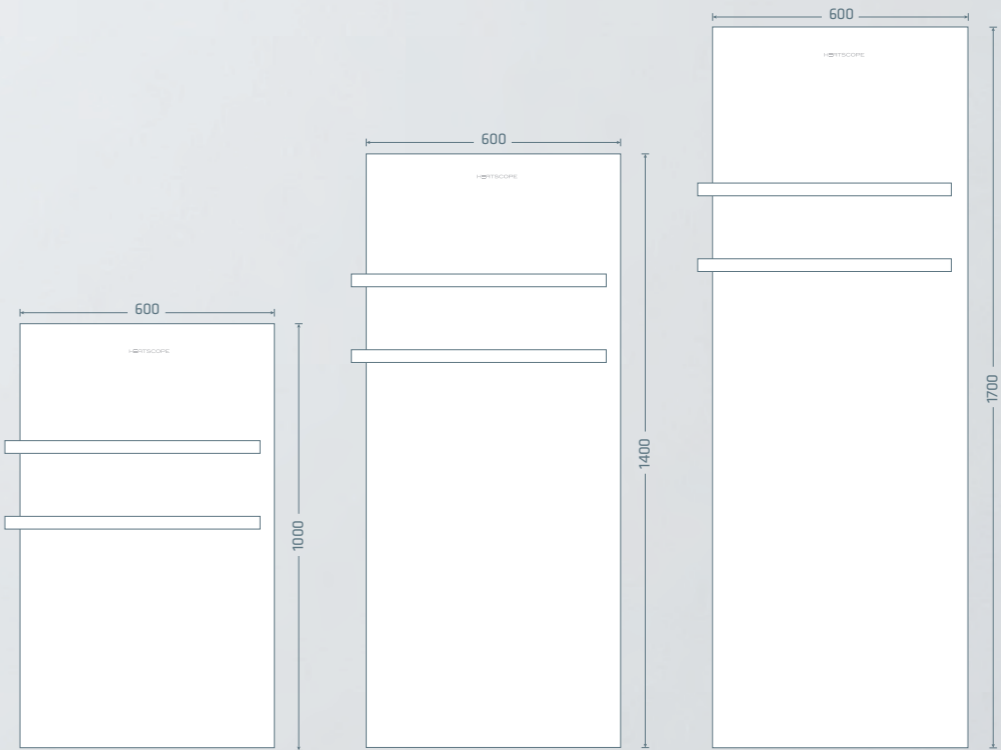

Model	Power
60-520	520 W
60-720	720 W
60-890	890 W

HEATSCOPE®
TUNE horizontal



HEATSCOPE® TUNE horizontal

Dimensions, towel rails
and versions

HEATSCOPE TUNE 60-520 horizontal



HEATSCOPE TUNE 60-720 horizontal



HEATSCOPE TUNE 60-890 horizontal

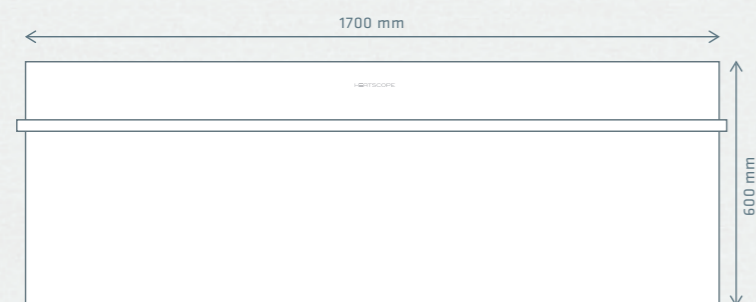

For horizontal models, the towel rail is only available in brushed stainless steel. The horizontal models can only have one towel rail each.

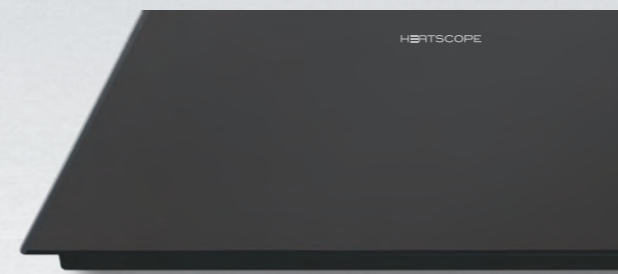

Matt black surface

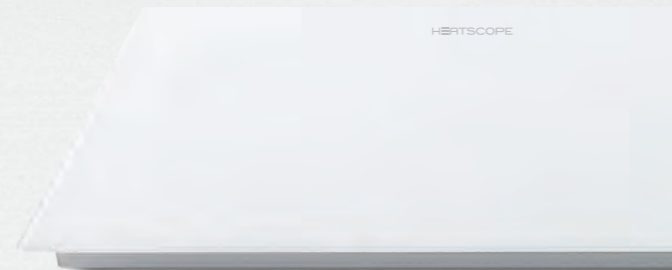

Matt white surface

HEATSCOPE TUNE Product overview



HEATSCOPE TUNE vertical Product overview

HEATSCOPE®

HEATSCOPE®

HEATSCOPE TUNE vertical with Music Interface

Model	Power	Description	Width x height mm	Colour	Article no.
HEATSCOPE TUNE 40-360 Music Interface	360 W	Infrared towel heater for vertical wall mounting with Music Interface	400 x 1200	matt white matt black	MHS-RTM40360WT.100 MHS-RTM40360AB.100
HEATSCOPE TUNE 40-530 Music Interface	530 W	Infrared towel heater for vertical wall mounting with Music Interface	400 x 1700	matt white matt black	MHS-RTM40530WT.100 MHS-RTM40530AB.100
HEATSCOPE TUNE 50-460 Music Interface	460 W	Infrared towel heater for vertical wall mounting with Music Interface	500 x 1200	matt white matt black	MHS-RTM50460WT.100 MHS-RTM50460AB.100
HEATSCOPE TUNE 50-720 Music Interface	720 W	Infrared towel heater for vertical wall mounting with Music Interface	500 x 1700	matt white matt black	MHS-RTM50720WT.100 MHS-RTM50720AB.100
HEATSCOPE TUNE 60-520 Music Interface	520 W	Infrared towel heater for vertical wall mounting with Music Interface	600 x 1000	matt white matt black	MHS-RTM60520WT.100 MHS-RTM60520AB.100
HEATSCOPE TUNE 60-720 Music Interface	720 W	Infrared towel heater for vertical wall mounting with Music Interface	600 x 1400	matt white matt black	MHS-RTM60720WT.100 MHS-RTM60720AB.100
HEATSCOPE TUNE 60-890 Music Interface	890 W	Infrared towel heater for vertical wall mounting with Music Interface	600 x 1700	matt white matt black	MHS-RTM60890WT.100 MHS-RTM60890AB.100

The Music Interface plays your favourite songs from your smartphone, iPad, etc. It is also easy to play your favourite radio stations on the HEATSCOPE TUNE via your radio app – with incredible sound quality. The music is invisibly integrated into the HEATSCOPE TUNE with cutting-edge technology.

HEATSCOPE TUNE vertical without Music Interface

Model	Power	Description	Width x height mm	Colour	Article no.
HEATSCOPE TUNE 40-360	360 W	Infrared towel heater for vertical wall mounting without Music Interface	400 x 1200	matt white matt black	MHS-RT40360WT.100 MHS-RT40360AB.100
HEATSCOPE TUNE 40-530	530 W	Infrared towel heater for vertical wall mounting without Music Interface	400 x 1700	matt white matt black	MHS-RT40530WT.100 MHS-RT40530AB.100
HEATSCOPE TUNE 50-460	460 W	Infrared towel heater for vertical wall mounting without Music Interface	500 x 1200	matt white matt black	MHS-RT50460WT.100 MHS-RT50460AB.100
HEATSCOPE TUNE 50-720	720 W	Infrared towel heater for vertical wall mounting without Music Interface	500 x 1700	matt white matt black	MHS-RT50720WT.100 MHS-RT50720AB.100
HEATSCOPE TUNE 60-520	520 W	Infrared towel heater for vertical wall mounting without Music Interface	600 x 1000	matt white matt black	MHS-RT60520WT.100 MHS-RT60520AB.100
HEATSCOPE TUNE 60-720	720 W	Infrared towel heater for vertical wall mounting without Music Interface	600 x 1400	matt white matt black	MHS-RT60720WT.100 MHS-RT60720AB.100
HEATSCOPE TUNE 60-890	890 W	Infrared towel heater for vertical wall mounting without Music Interface	600 x 1700	matt white matt black	MHS-RT60890WT.100 MHS-RT60890AB.100

HEATSCOPE TUNE vertical accessories

Model	Description	Width x height x depth mm	Colour	Article no.
Towel rail V 400	Towel rail with magnetic mounting	400 x 96 x 98	chrome	MHS-RT-ST40CR
Towel rail V 500	Towel rail with magnetic mounting	500 x 96 x 98	chrome	MHS-RT-ST50CR
Towel rail V 600	Towel rail with magnetic mounting	600 x 96 x 98	chrome	MHS-RT-ST60CR
Towel rail V 400E	Towel rail with magnetic mounting	400 x 96 x 98	Brushed stainless steel	MHS-RT-ST40SL
Towel rail V 500E	Towel rail with magnetic mounting	500 x 96 x 98	Brushed stainless steel	MHS-RT-ST50SL
Towel rail V 600E	Towel rail with magnetic mounting	600 x 96 x 98	Brushed stainless steel	MHS-RT-ST60SL
Towel rail V 400S	Towel rail with magnetic mounting	400 x 96 x 98	matt black	MHS-RT-ST40AB
Towel rail V 500S	Towel rail with magnetic mounting	500 x 96 x 98	matt black	MHS-RT-ST50AB
Towel rail V 600S	Towel rail with magnetic mounting	600 x 96 x 98	matt black	MHS-RT-ST60AB

HEATSCOPE TUNE horizontal Product overview

HEATSCOPE TUNE horizontal with Music Interface

Model	Power	Description	Width x height mm	Colour	Article no.
HEATSCOPE TUNE 60-520 Music Interface	520 W	Infrared towel heater for horizontal wall mounting with Music Interface	1000 x 600	matt white matt black	MHS-RTHM60520WT.100 MHS-RTHM60520AB.100
HEATSCOPE TUNE 60-720 Music Interface	720 W	Infrared towel heater for horizontal wall mounting with Music Interface	1400 x 600	matt white matt black	MHS-RTHM60720WT.100 MHS-RTHM60720AB.100
HEATSCOPE TUNE 60-890 Music Interface	890 W	Infrared towel heater for horizontal wall mounting with Music Interface	1700 x 600	matt white matt black	MHS-RTHM60890WT.100 MHS-RTHM60890AB.100

HEATSCOPE TUNE horizontal without Music Interface

Model	Power	Description	Width x height mm	Colour	Article no.
HEATSCOPE TUNE 60-520	520 W	Infrared towel heater for horizontal wall mounting without Music Interface	1000 x 600	matt white matt black	MHS-RTH60520WT.100 MHS-RTH60520AB.100
HEATSCOPE TUNE 60-720	720 W	Infrared towel heater for horizontal wall mounting without Music Interface	1400 x 600	matt white matt black	MHS-RTH60720WT.100 MHS-RTH60720AB.100
HEATSCOPE TUNE 60-890	890 W	Infrared towel heater for horizontal wall mounting without Music Interface	1700 x 600	matt white matt black	MHS-RTH60890WT.100 MHS-RTH60890AB.100

HEATSCOPE®

Pure luxury for your own bathroom. The TUNE brings your towels to a perfect feel-good warmth and simultaneously plays your favorite songs.

Connection types
and technical
data sheets



Connection types for the HEATSCOPE TUNE

with integrated touch control, on-demand timer and weekly timer

Overview of displays and controls on the HEATSCOPE TUNE control panel

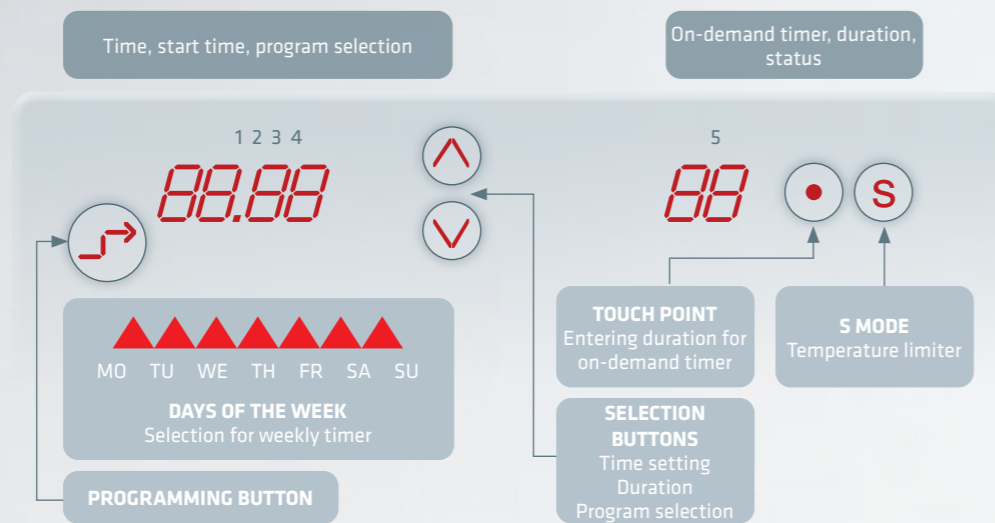

The HEATSCOPE TUNE only requires one electrical connection at the desired installation location, as the controller is integrated into the HEATSCOPE TUNE. Ideally, the connection should be 30 cm from the bottom edge of the HEATSCOPE TUNE, in the centre behind the device or simply somewhere where the connection is behind the device and therefore covered by the HEATSCOPE TUNE.

Connection via a socket

If possible, the flush-mounted socket should be behind the device so that the HEATSCOPE TUNE covers the connection. The standard length of the cable is 1.7 m. As the HEATSCOPE TUNE has an Evoline flat plug as standard, it is easy to plug in behind the device during installation, so that the connection is hidden from view.

Direct connection without plug

If possible, the flush-mounted socket for direct connection should be behind the device so that the HEATSCOPE TUNE covers the connection. The standard length of the cable is 1.7 m. For this type of connection, the installer removes the standard Evoline flat plug, cuts the cable to the right length and connects it directly.

Functions

- Time and day setting
- Individual brightness setting for the control panel so that you can adjust the HEATSCOPE TUNE perfectly to your lighting conditions
- Weekly timer with individual day selection offers four program memories. It is easy to put the programs together individually or to overlap them.
- On-demand timer for ad hoc use of the HEATSCOPE TUNE
- S mode = Soft mode temperature limiter for on-demand timer and weekly timer. Soft mode can be activated at any time or set in the weekly programming.
- Display for the set programs and durations

Initial use

- When the power cable is connected to a socket, the entire control interface appears briefly. This short initialisation phase lasts for approx. 1 minute. After that, only the touch point at the top right is visible and the HEATSCOPE TUNE is ready.

HEATSCOPE®

Infrared towel heater

HEATSCOPE TUNE 40-360

HEATSCOPE®

Technical data

Front	ESG glass with ceramic screen printing in matt white or matt black
Rear	Powder coating RAL 9005 (black version) RAL 9010 (white version)
Voltage	230 VAC, 50Hz
Power	360 W
Current	1.6 A
Protection class	IP 44
Weight	11 kg

Functions

- ON/OFF switch
- Proximity sensor (switches on before the glass surface is touched)
- Time and day setting
- Individual brightness setting
- Weekly timer (four activation times per day)
- On-demand timer for ad hoc use
- Temperature limiter to 75% (S mode)

Back view

Hole pattern for HEATSCOPE TUNE 40-360

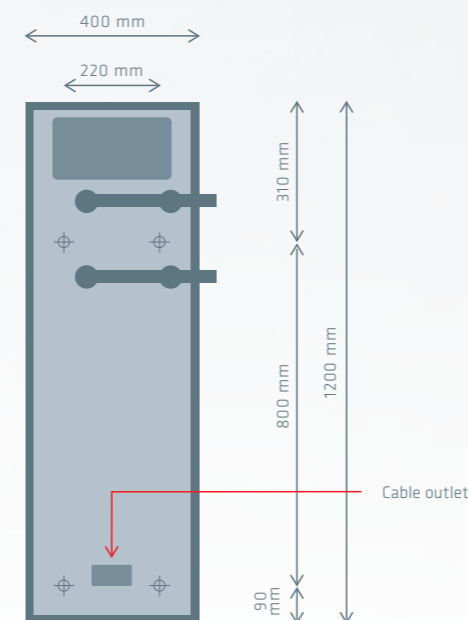

Front view

Outer dimensions for towel rail 400 mm

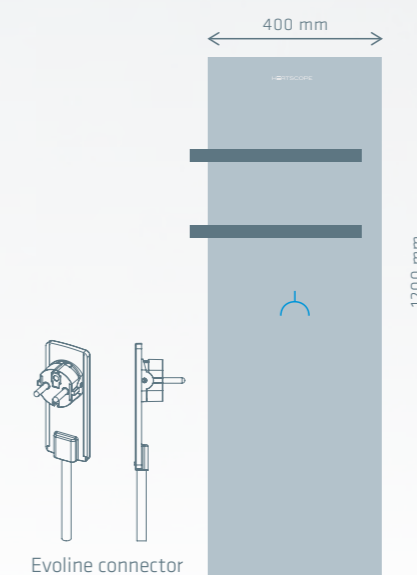

Side view

- Wall clearance of towel rail 106 mm
- Device depth 30 mm
- Rear ventilation 24 mm
- Installation depth 54 mm
- Power connection located behind the device

Infrared towel heater

HEATSCOPE TUNE 40-530

HEATSCOPE®

Technical data

Front	ESG glass with ceramic screen printing in matt white or matt black
Rear	Powder coating RAL 9005 (black version) RAL 9010 (white version)
Voltage	230 VAC, 50Hz
Power	530 W
Current	2.3 A
Protection class	IP 44
Weight	16 kg

Functions

- ON/OFF switch
- Proximity sensor (switches on before the glass surface is touched)
- Time and day setting
- Individual brightness setting
- Weekly timer (four activation times per day)
- On-demand timer for ad hoc use
- Temperature limiter to 75% (S mode)

Back view

Hole pattern for HEATSCOPE TUNE 40-530

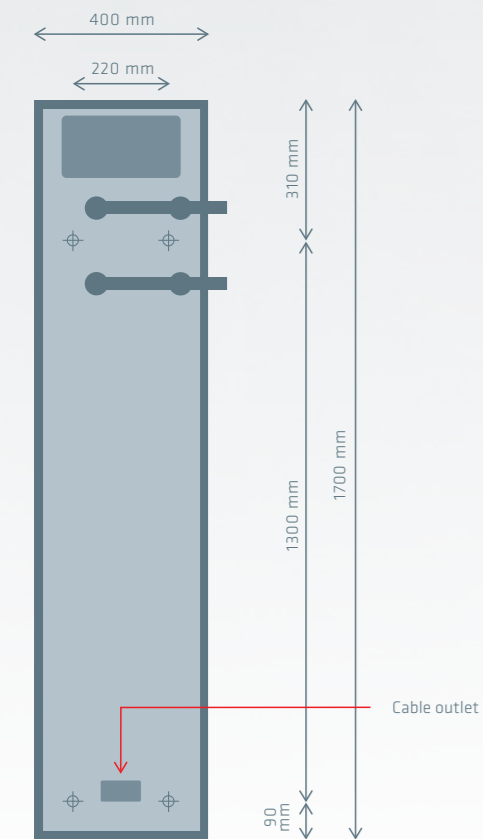

Front view

Outer dimensions for towel rail 500 mm

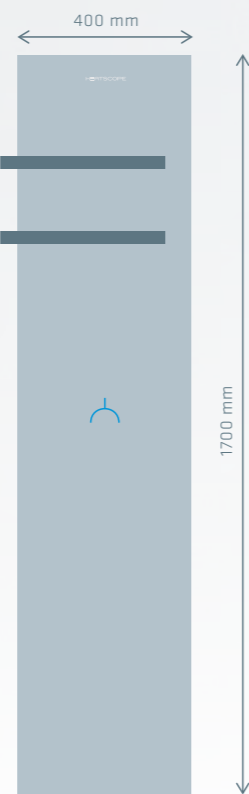

Side view

Wall clearance of towel rail
106 mm

Device depth
30 mm

Rear ventilation
24 mm

Installation depth
54 mm

Power connection
located behind the device

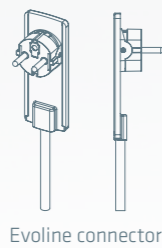

Infrared towel heater

HEATSCOPE TUNE 50-460

HEATSCOPE®

Technical data

Front	ESG glass with ceramic screen printing in matt white or matt black
Rear	Powder coating RAL 9005 (black version) RAL 9010 (white version)
Voltage	230 VAC, 50Hz
Power	460 W
Current	2.0 A
Protection class	IP 44
Weight	14 kg

Functions

- ON/OFF switch
- Proximity sensor (switches on before the glass surface is touched)
- Time and day setting
- Individual brightness setting
- Weekly timer (four activation times per day)
- On-demand timer for ad hoc use
- Temperature limiter to 75% (S mode)

Back view

Hole pattern for HEATSCOPE TUNE 50-460

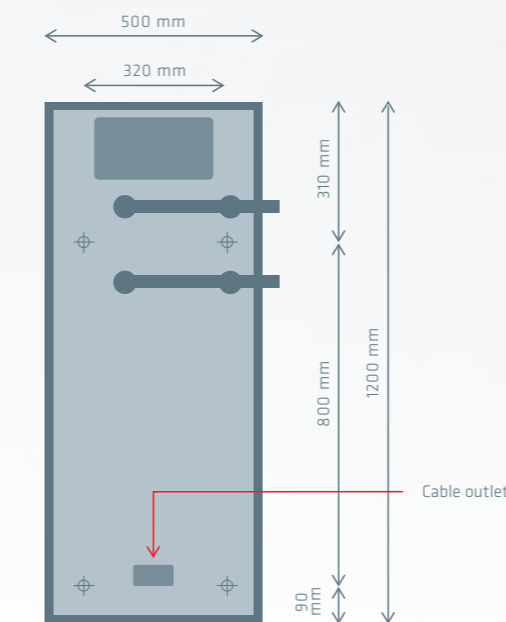

Front view

Outer dimensions for towel rail 500 mm

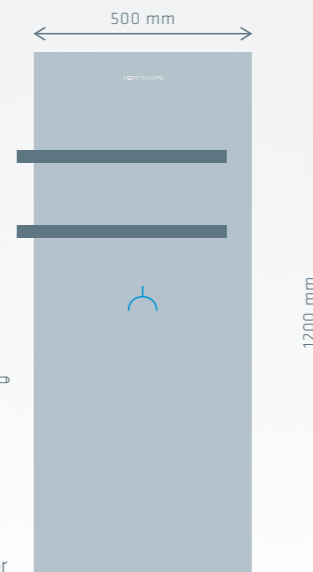

Side view

Wall clearance of towel rail
106 mm

Device depth
30 mm

Rear ventilation
24 mm

Installation depth
54 mm

Power connection
located behind the device

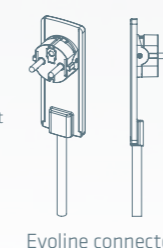

Infrared towel heater

HEATSCOPE TUNE 50-720

HEATSCOPE®

Technical data

Front	ESG glass with ceramic screen printing in matt white or matt black
Rear	Powder coating RAL 9005 (black version) RAL 9010 (white version)
Voltage	230 VAC, 50Hz
Power	720 W
Current	3.1 A
Protection class	IP 44
Weight	19 kg

Functions

- ON/OFF switch
- Proximity sensor (switches on before the glass surface is touched)
- Time and day setting
- Individual brightness setting
- Weekly timer (four activation times per day)
- On-demand timer for ad hoc use
- Temperature limiter to 75% (S mode)

Back view

Hole pattern for HEATSCOPE TUNE 50-720

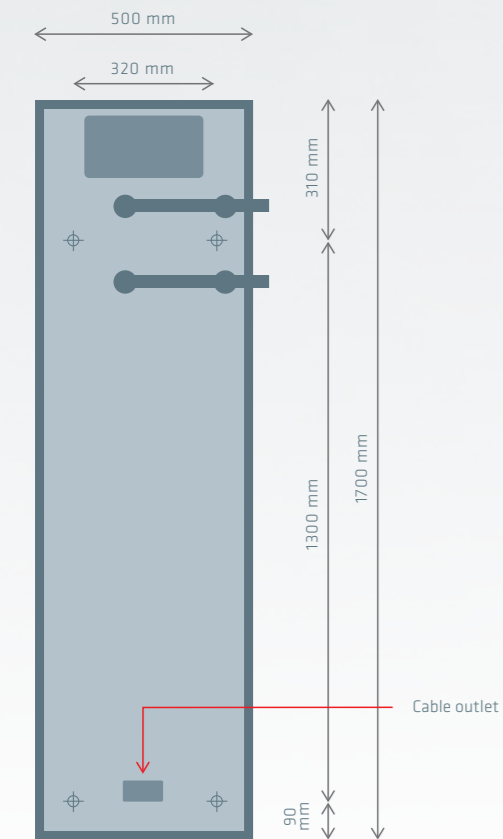

Front view

Outer dimensions for towel rail 500 mm

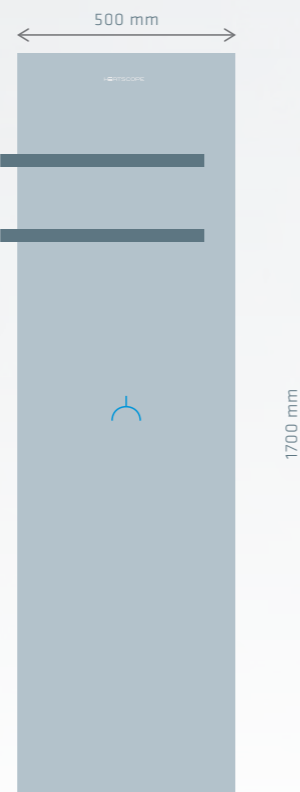

Side view

Wall clearance of towel rail
106 mm

Device depth
30 mm

Rear ventilation
24 mm

Installation depth
54 mm

Power connection
located behind the device

Infrared towel heater

HEATSCOPE TUNE 60-520

HEATSCOPE®

Technical data

Front	ESG glass with ceramic screen printing in matt white or matt black
Rear	Powder coating RAL 9005 (black version) RAL 9010 (white version)
Voltage	230 VAC, 50Hz
Power	520 W
Current	2.3 A
Protection class	IP 44
Weight	14 kg

Functions

- ON/OFF switch
- Proximity sensor (switches on before the glass surface is touched)
- Time and day setting
- Individual brightness setting
- Weekly timer (four activation times per day)
- On-demand timer for ad hoc use
- Temperature limiter to 75% (S mode)

Back view

Hole pattern for HEATSCOPE TUNE 60-520

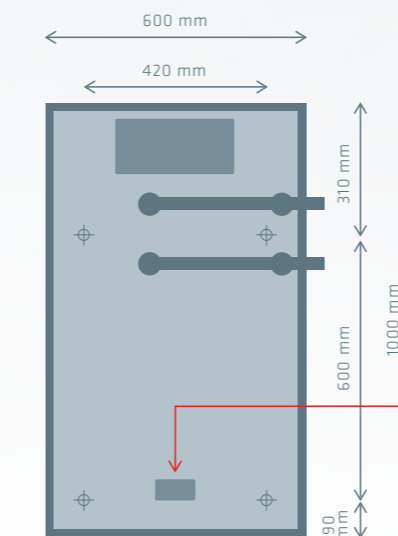

Front view

Outer dimensions for towel rail 600 mm

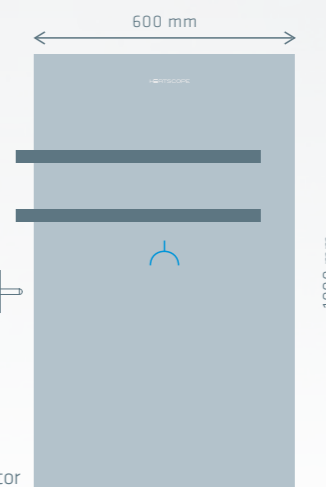

Side view

Wall clearance of towel rail
106 mm

Device depth
30 mm

Rear ventilation
24 mm

Installation depth
54 mm

Power connection
located behind the device

Infrared towel heater

HEATSCOPE TUNE 60-720

HEATSCOPE®

Technical data

Front	ESG glass with ceramic screen printing in matt white or matt black
Rear	Powder coating RAL 9005 (black version) RAL 9010 (white version)
Voltage	230 VAC, 50Hz
Power	720 W
Current	3.1 A
Protection class	IP 44
Weight	19 kg

Functions

- ON/OFF switch
- Proximity sensor (switches on before the glass surface is touched)
- Time and day setting
- Individual brightness setting
- Weekly timer (four activation times per day)
- On-demand timer for ad hoc use
- Temperature limiter to 75% (S mode)

Back view

Hole pattern for HEATSCOPE TUNE 60-720

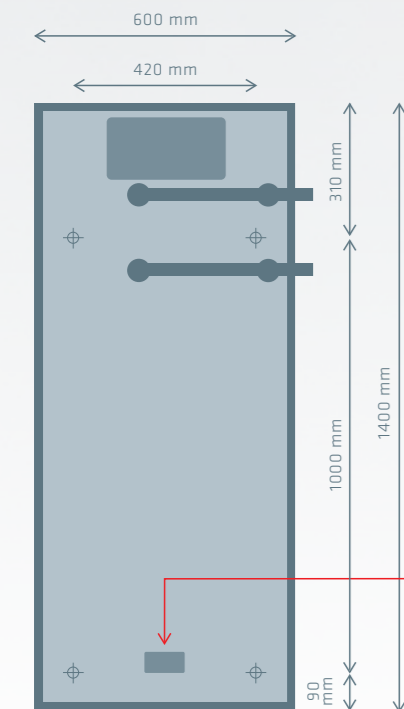

Cable outlet

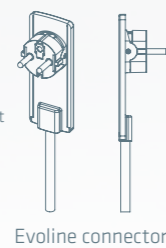

Evoline connector

Front view

Outer dimensions for towel rail 600 mm

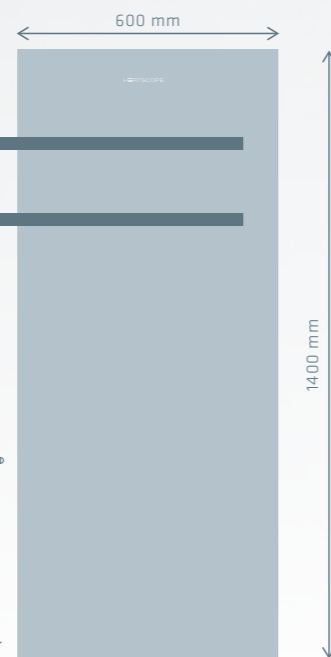

Wall clearance of towel rail
106 mm

Device depth
30 mm

Rear ventilation
24 mm

Installation depth
54 mm

Power connection
located behind the device

Side view

Infrared towel heater

HEATSCOPE TUNE 60-890

HEATSCOPE®

Technical data

Front	ESG glass with ceramic screen printing in matt white or matt black
Rear	Powder coating RAL 9005 (black version) RAL 9010 (white version)
Voltage	230 VAC, 50Hz
Power	890 W
Current	3.9 A
Protection class	IP 44
Weight	22 kg

Functions

- ON/OFF switch
- Proximity sensor (switches on before the glass surface is touched)
- Time and day setting
- Individual brightness setting
- Weekly timer (four activation times per day)
- On-demand timer for ad hoc use
- Temperature limiter to 75% (S mode)

Back view

Hole pattern for HEATSCOPE TUNE 60-890

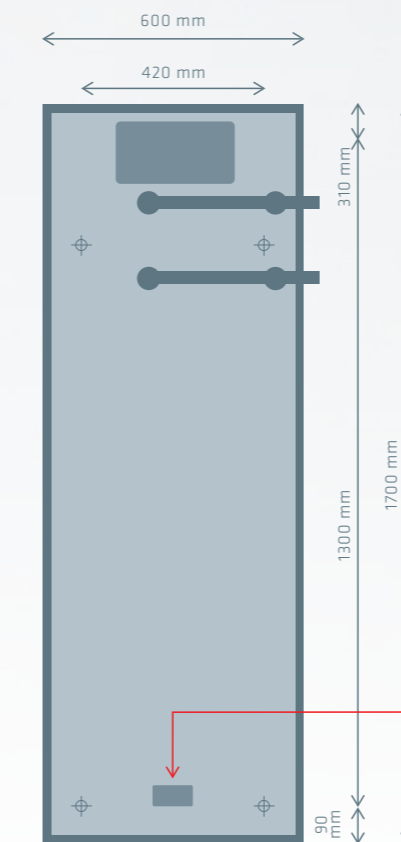

Cable outlet

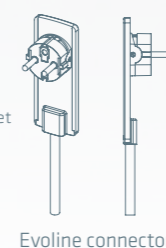

Evoline connector

Front view

Outer dimensions for towel rail 600 mm

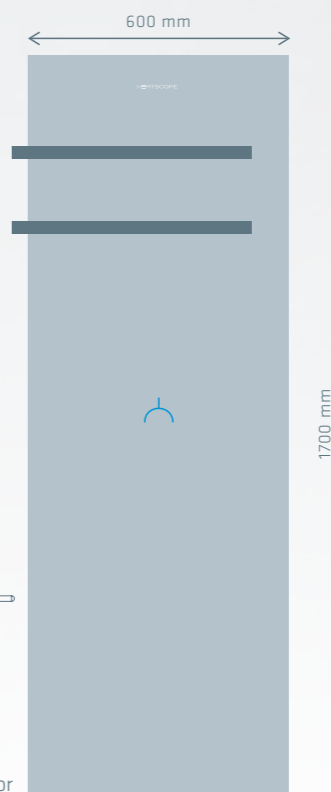

Wall clearance of towel rail
106 mm

Device depth
30 mm

Rear ventilation
24 mm

Installation depth
54 mm

Power connection
located behind the device

Side view

Infrared towel heater

HEATSCOPE TUNE 60-520

HEATSCOPE®

Technical data

Front	ESG glass with ceramic screen printing in matt white or matt black
Rear	Powder coating RAL 9005 (black version) RAL 9010 (white version)
Voltage	230 VAC, 50Hz
Power	520 W
Current	2.3 A
Protection class	IP 44
Weight	14 kg

Functions

- ON/OFF switch
- Proximity sensor (switches on before the glass surface is touched)
- Time and day setting
- Individual brightness setting
- Weekly timer (four activation times per day)
- On-demand timer for ad hoc use
- Temperature limiter to 75% (S mode)

Front view

Outer dimensions for towel rail:
total length 1040 mm

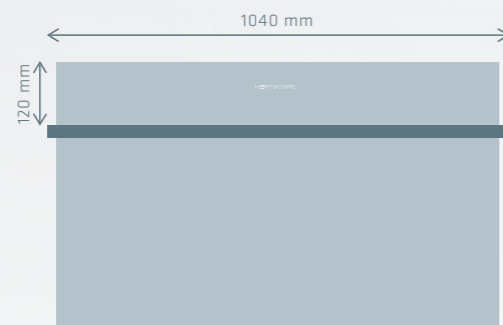

Back view

Hole pattern for
HEATSCOPE TUNE 60-520

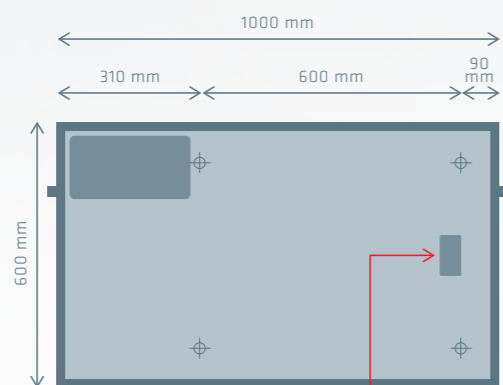

Cable outlet

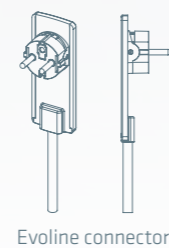

Evoline connector

Ansicht Seite

- Wall clearance of towel rail**
120 mm
- Device depth**
30 mm
- Rear ventilation**
4 mm
- Installation depth**
54 mm
- Power connection**
located behind the device

Infrared towel heater

HEATSCOPE TUNE 60-720

HEATSCOPE®

Technical data

Front	ESG glass with ceramic screen printing in matt white or matt black
Rear	Powder coating RAL 9005 (black version) RAL 9010 (white version)
Voltage	230 VAC, 50Hz
Power	720 W
Current	3.1 A
Protection class	IP 44
Weight	19 kg

Functions

- ON/OFF switch
- Proximity sensor (switches on before the glass surface is touched)
- Time and day setting
- Individual brightness setting
- Weekly timer (four activation times per day)
- On-demand timer for ad hoc use
- Temperature limiter to 75% (S mode)

Front view

Outer dimensions for towel rail:
total length 1440 mm

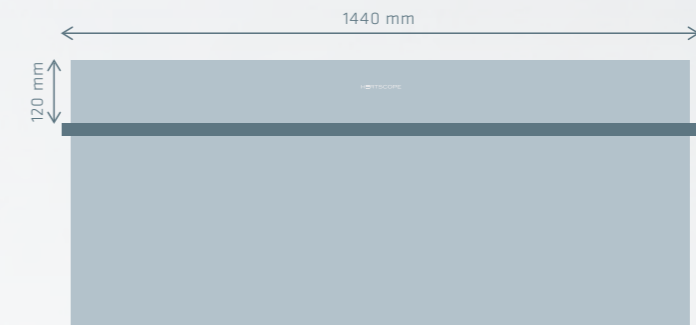

Back view

Hole pattern for
HEATSCOPE TUNE 60-720

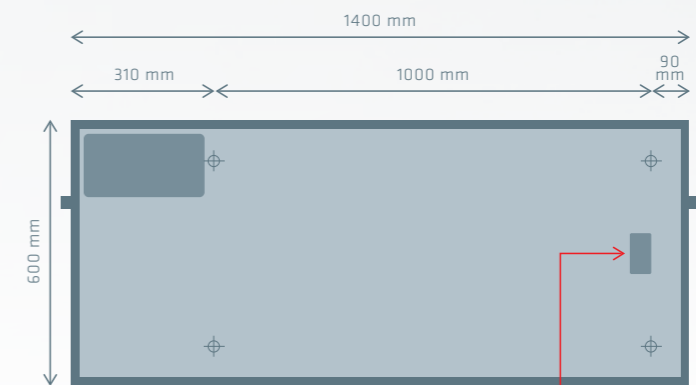

Cable outlet

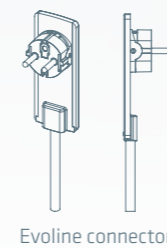

Evoline connector

Side view

- Wall clearance of towel rail**
120 mm
- Device depth**
30 mm
- Rear ventilation**
24 mm
- Installation depth**
54 mm
- Power connection**
located behind the device

Infrared towel heater

HEATSCOPE TUNE 60-890

HEATSCOPE®

Technical data

Front	ESG glass with ceramic screen printing in matt white or matt black
Rear	Powder coating RAL 9005 (black version) RAL 9010 (white version)
Voltage	230 VAC, 50Hz
Power	890 W
Current	3.7 A
Protection class	IP 44
Weight	22 kg

Functions

- ON/OFF switch
- Proximity sensor (switches on before the glass surface is touched)
- Time and day setting
- Individual brightness setting
- Weekly timer (four activation times per day)
- On-demand timer for ad hoc use
- Temperature limiter to 75% (S mode)

Front view

Outer dimensions for towel rail:
total length 1740 mm

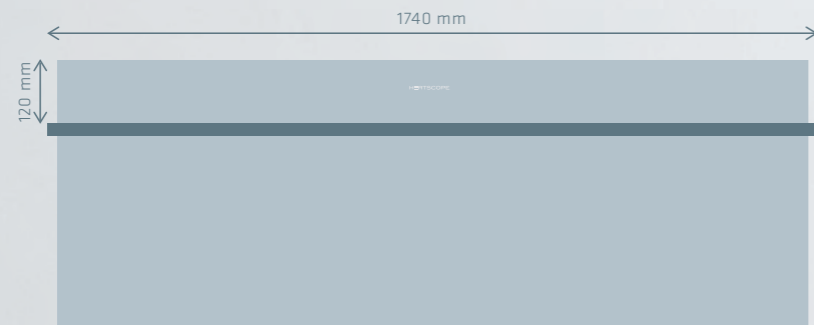

Side view

- Wall clearance of towel rail**
120 mm
- Device depth**
30 mm
- Rear ventilation**
24 mm
- Installation depth**
54 mm
- Power connection**
located behind the device

Back view

Hole pattern for
HEATSCOPE TUNE 60-890

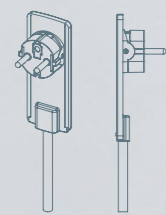

Evoline connector

HEATSCOPE TUNE Music Interface



Connection to the HEATSCOPE TUNE Music Interface

HEATSCOPE®



HEATSCOPE TUNE Bluetooth

If you have ordered the HEATSCOPE TUNE with the Music Interface option, you can follow the steps below to play your favourite songs from your smartphone, iPad, iPod, etc. The HEATSCOPE TUNE can even play your favourite radio station for you. The music is invisibly integrated into the HEATSCOPE TUNE.

Follow these steps:

- Make sure that the HEATSCOPE TUNE is connected to the power and switched on.
- PAIR your device with the HEATSCOPE TUNE Music Interface by following the prompts on your device.
- You can read about how to do this in the operating instructions for your Bluetooth-compatible device if necessary.

General process for pairing:

- Go to the settings menu on your device (smartphone, iPad, iPod) and activate Bluetooth. The pairing process varies greatly between different devices.
- It takes approximately 1-5 minutes to establish the connection between the Music Interface and the Bluetooth-compatible mobile device.
- When you activate Bluetooth, your device will search for possible connections. After a few seconds, you should see HEATSCOPE TUNE MUSIC appear in the list. Select HEATSCOPE TUNE MUSIC. Depending on your device, you will then see a prompt to pair your device.
- If it asks for a password, enter '0000'. The pairing process is now complete.
- Open your music files or select the radio app and enjoy the music!
- You can adjust the volume via your device (smartphone, iPad or iPod).

Disconnecting the Bluetooth link:

Follow the prompts on your device to disconnect.

FAQs

Why doesn't my device stay connected to the Music Interface when I go out of range?

- You may have been out of range for more than 5 minutes. Please connect again manually on your device. You generally won't need the PIN again to do this, unless you have deleted the Music Interface from the list on your smartphone or iPad.
- There could be another Bluetooth-compatible device paired with the HEATSCOPE TUNE. Disconnect this and connect your device again.

How many different devices can be used with the Music Interface?

- Up to eight devices (the ninth device added will replace the first)

I can't connect any more.

- Turn off the power for at least three minutes – either by pulling out the plug or switching off the fuse in the distribution board.

Save your battery by switching off Bluetooth on your device when you aren't using the function.

Operating instructions for HEATSCOPE TUNE vertical and horizontal



HEATSCOPE TUNE with integrated weekly timer and on-demand timer.

Please take the time to read the operating instructions carefully.

HEATSCOPE TUNE functions

- ON/OFF switch
- Time and day setting
- Individual brightness setting for control panel
- Weekly timer with individual day selection offers four program memories. It is easy to put the programs together individually or to overlap them.
- On-demand timer for ad hoc use
- S mode = Soft mode temperature limiter for on-demand timer and weekly timer
- Display for the set programs and durations
- Proximity sensor

Initial use of the HEATSCOPE TUNE

HEATSCOPE®

Overview of displays and controls on the HEATSCOPE TUNE control panel

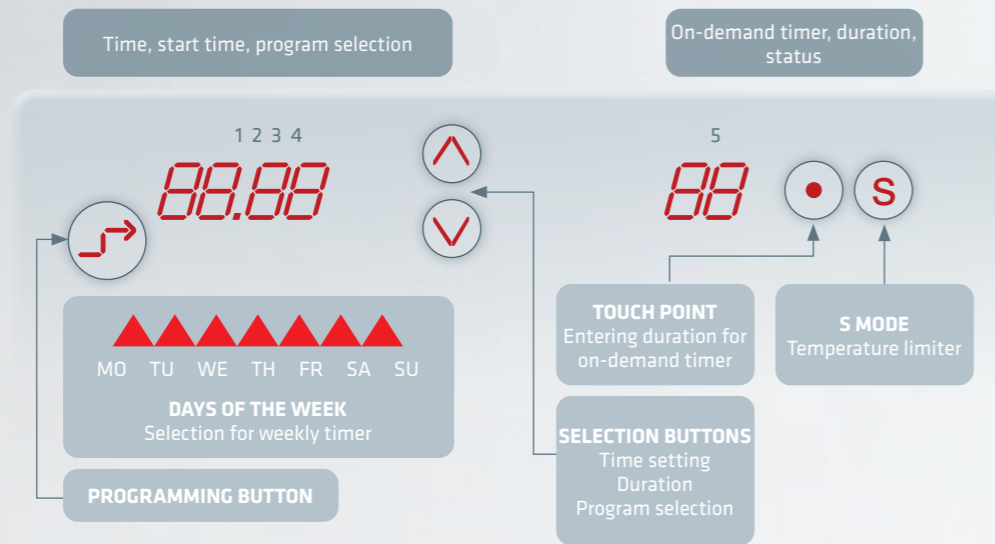

Connect the power cable to a socket and press the ON/OFF switch (on the side of the HEATSCOPE TUNE). The short initialisation phase lasts for approx. 1 minute. After that, only the touch point at the top right is visible and the HEATSCOPE TUNE is ready to use.

- If you move your hand towards the touch point without touching the HEATSCOPE TUNE, the programming button and the time will automatically appear on the left.
- If you don't change any settings, the display will switch off again after a few seconds. Only the touch point on the right will remain illuminated.

Setting the day and time

HEATSCOPE®

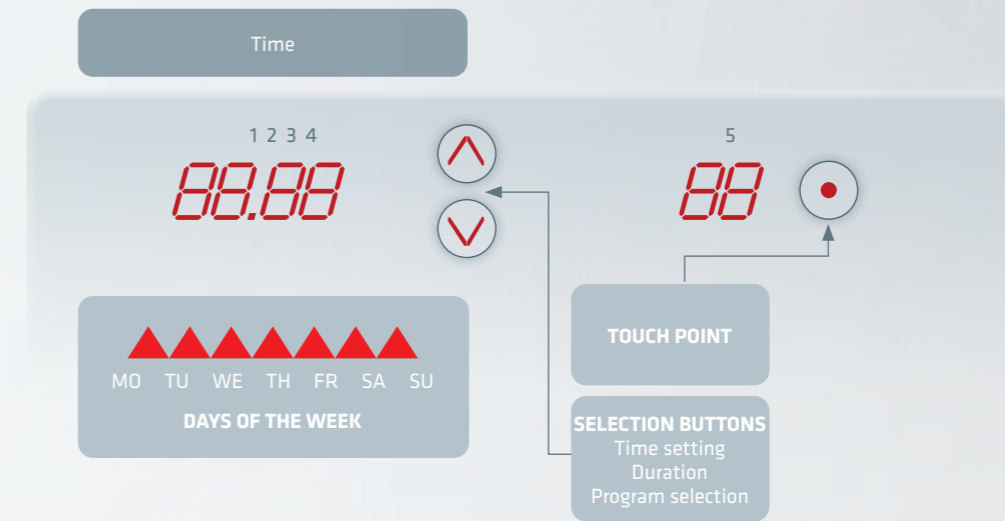

1. Hold your finger on the touch point until the seven triangles start to flash on the left side.
2. Touch the relevant triangle to select the current day of the week and then press the touch point to confirm. If you have selected the wrong day, simply touch the correct day again. If you have accidentally already pressed the touch point to confirm, start again at Step 1.
3. Once you have confirmed the day, only the displays needed for the next step will be illuminated - i.e. for setting the time. Use the selection button to set the first number of the four-digit time display and then press the touch point to confirm. The HEATSCOPE TUNE will take you through each of the four digits for the time display. Confirm each one with the touch point. Once you have confirmed the last number of the four-digit time display, the HEATSCOPE TUNE will automatically exit the menu for setting the day and time.
4. **C0** - normal operation (standby, only the red spot is visible)
C1 - time is permanently displayed
C2 - proximity sensor is switched off (standby, only the red spot is visible)

- If you stop programming the time and do not confirm all four digits for the time with the touch point, the HEATSCOPE TUNE will automatically exit the time programming menu after a few seconds and will retain the most recently confirmed value.
- In the event of a power failure, the time and day settings will be stored for several days.

Setting the brightness

HEATSCOPE®

1. Hold your finger on the programming button until the selection buttons start to flash and SET 01 appears on the display (approx. 10 seconds). Take your finger off the programming button.
2. Use the up and down selection buttons to change the brightness until it suits your lighting and the display is easy to read. Use the programming button to confirm the setting and save the brightness.



- If you stop adjusting the brightness and/or do not confirm the setting, the HEATSCOPE TUNE will automatically leave the menu after a few seconds and will retain the most recently confirmed value.
- In the event of a power failure, the chosen brightness setting will be stored for several days.

General switch-on and switch-off

The ON/OFF switch is on the side of the HEATSCOPE TUNE. Press the switch to turn the device off. We recommend switching the device off if you go on holiday or are away for a long period.

Programming a week

HEATSCOPE®

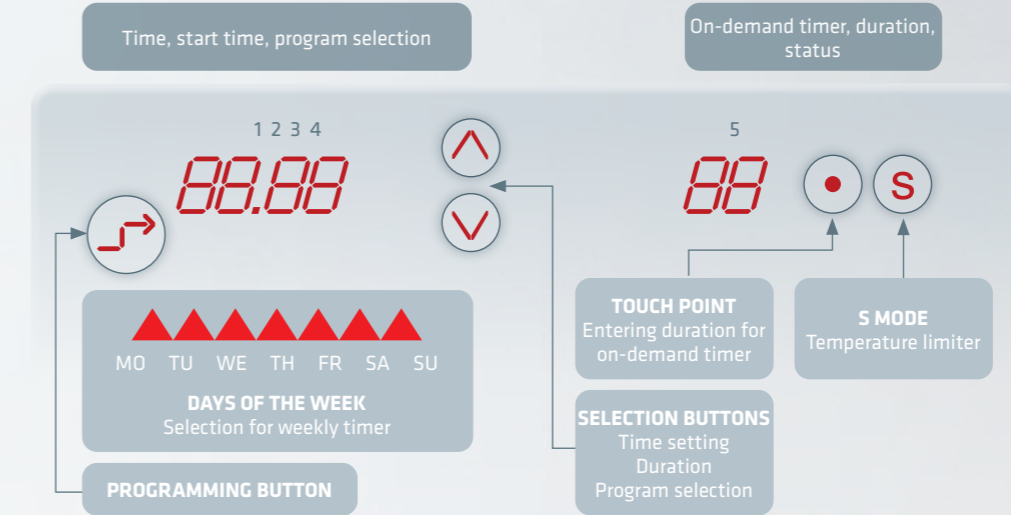

Setting the weekly timer (memory spaces: P1, P2, P3, P4, P5, P6, P7 and P8)

(Explanation before programming)

You can freely configure eight programs per week. Move your hand towards the touch point without touching it. Then touch the programming button once to see what has already been programmed. You can use the selection button to move back and forth between the eight memory spaces. The display for the relevant memory space will switch between the program (e.g. P1) and the values set for the memory space.

To start the programming mode for a selected program, press the programming button again. If you do not touch any buttons for 30 seconds, the HEATSCOPE TUNE will automatically exit the program menu and will only retain values that have been confirmed with the programming button.

The first time the device is used, all values such as the start time and duration will be set to zero and all days will flash, as no selections have been made.

Programming a week

HEATSCOPE®

(Process)

1. Press the programming button once and use the selection buttons to select the memory space. Confirm your selection with the programming button.

2. Once you have started programming mode with Step 1, only the buttons and displays needed for the next step will be illuminated – i.e. for setting the day of the week. Select the days of the week. Touch any days you wish to select. The selected days will light up constantly. Once you have selected the days when you want the HEATSCOPE TUNE to run automatically, press the programming button to confirm your selection.

3. Once you have selected the days, you now need to set the desired start time. First use the selection buttons to select the time on the four-digit time display (24-hour time display) and confirm each entry with the programming button.

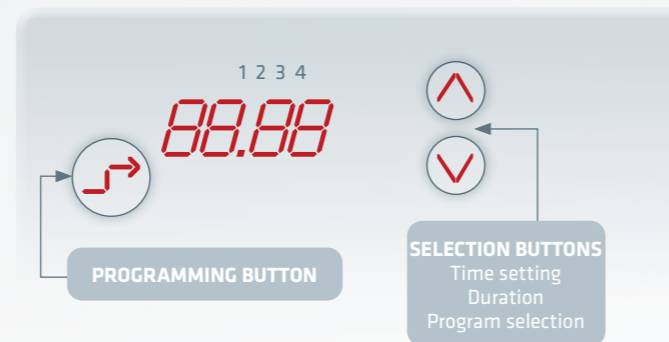
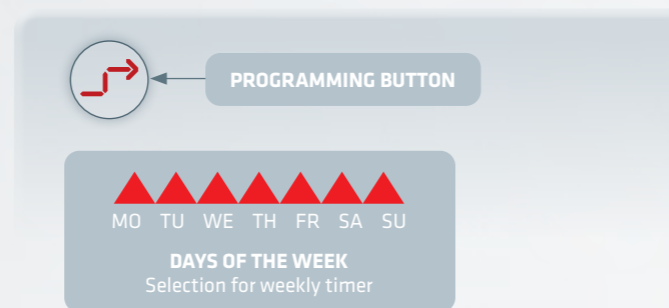
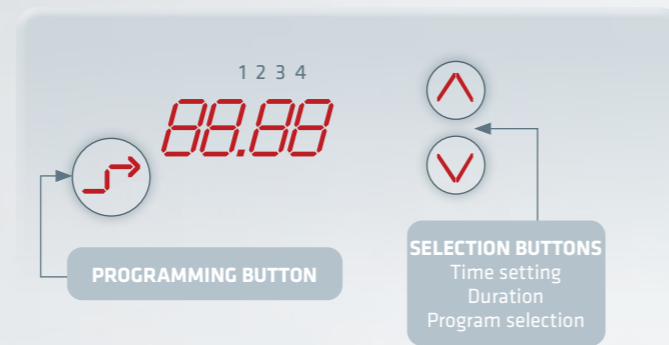

Programming a week

HEATSCOPE®

4. When you have confirmed the final digit for the start time with the programming button, the on-demand timer display on the right will light up and you can use the selection buttons or the touch point to set the duration in 10-minute intervals. Touch the programming button to confirm the selected duration. The first start time and the subsequent duration are now programmed for the selected days.

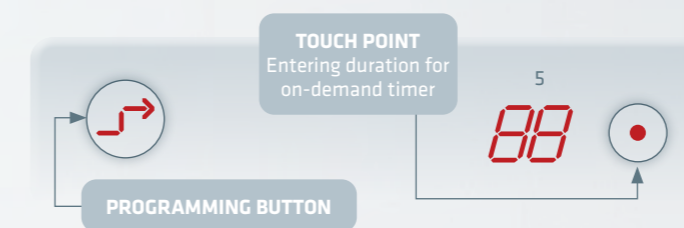

5. The S now flashes on the right side. The S is used to select the operating mode. If you want the HEATSCOPE TUNE to run at a lower temperature in the set time, press the S and it will light up constantly. The S mode is activated. The HEATSCOPE TUNE is now limited to a lower temperature. Please note that in this mode, it takes slightly longer to warm and dry your towels. If you want the HEATSCOPE TUNE to run in normal mode, do not press the S. Use the programming button to confirm your selection and save the operating mode for the selected time.

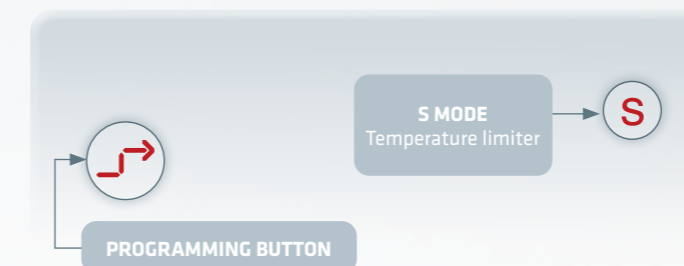

Deactivating the timer

- Switching off the device at the ON/OFF switch deactivates the weekly timer. The programmed days, idle times and running times will remain saved.
- Press the programming button once and select the memory space. Then press all days of the week that are not flashing, until all seven days are flashing, and press the programming button to confirm your selection. The weekly timer is now deactivated for the selected memory space. The switch-on times and running times are retained and are now deactivated.
- Repeat this step for all of the eight memory spaces that you have programmed.
- In the event of a power failure, the programmed times will be stored for several days.

Starting the on-demand timer in two steps

(Starting the on-demand timer)

1. Press the touch point multiple times to adjust the time in 20-minute intervals. (20, 40, 60, 80 and 90 minutes).

2. S mode

Once you have set the duration, you have the option to set the temperature of the HEATSCOPE TUNE to a lower level for the selected duration by pressing the S mode button. Please note that in this mode, it takes slightly longer to warm and dry your towels.

- A few seconds after you have selected the time, the display changes to 'on' in the operating mode. The HEATSCOPE TUNE is now switched on. If you have activated S mode, the HEATSCOPE TUNE will display this. If the 'S' does not light up simultaneously with the 'on' display, the S mode is not activated.
- The automatic switch-off is always activated and the HEATSCOPE TUNE switches off automatically once the selected running time has ended.
- Press the touch point again to display the remaining time.
- If you wish to switch the HEATSCOPE TUNE off before the end, press the touch point several times until '00' appears on the display. The HEATSCOPE TUNE is now switched off.
- The on-demand timer can be activated at any time and independently of the programmed weekly timer. Thanks to the extremely fast response time of the HEATSCOPE TUNE, you can enjoy the comfort of the HEATSCOPE TUNE at short notice, even outside of the programmed times.

HEATSCOPE®

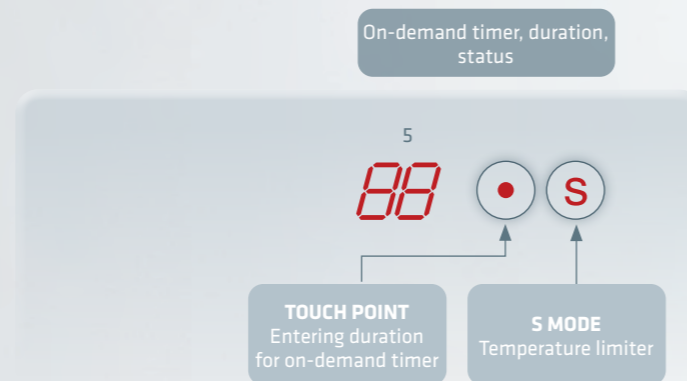

Information

Internal control

The heater has safety thermostats and an internal automatic regulation system that ensures optimum control of the HEATSCOPE TUNE.

The temperature is reduced by 25% in S mode.

Caution:

Please do not place any items of clothing directly over the heater – your chosen towel rail is provided for this purpose.

Warranty

Ten-year warranty on all components and original accessories of the HEATSCOPE TUNE with integrated weekly timer and on-demand timer.

We hope you enjoy your HEATSCOPE TUNE!

HEATSCOPE TUNE installation instructions

Installation and mounting guidelines

Dear Customer,

Thank you for choosing a HEATSCOPE product, designed with the latest technology. Please read the installation instructions carefully to make sure you can enjoy your efficient and elegant infrared heater or infrared towel heater for a long time to come.

Installation

Installation must be performed by an electrician or a similarly qualified professional. All applicable standards and regulations must be observed during installation. Your electrician will know the regulations and will be happy to advise you.

The infrared heaters and infrared towel heaters rails from HEATSCOPE comply with the electricity standard of the Swiss Electrotechnical Association (SEV), which has tested and certified the devices. These test reports are also checked by the Federal Inspectorate for Heavy Current Installations and comply in full with the standards of the European Union (CE).

1. General guidelines

The following general guidelines must be followed. If they are not observed, HEATSCOPE will accept no liability in the event of damage.

The device must not be opened or modified. Opening the device will void the warranty immediately.

The supplied installation materials must be used for installation. This ensures that the device is secured correctly to the wall or ceiling.

The minimum spacing between the side of the device and solid objects such as walls made of masonry, wood, lightweight boards or plasterboard must be at least 5 cm.

Highly flammable materials such as curtains, plastic covers, pictures, etc. must be kept at least 10 cm away from the heater.

The heater must not be completely or partially covered by curtains, sofas or other furniture. A space of at least 1 m must be kept clear in front of the infrared heater.

If the heater is installed behind a door, it must be ensured that a fixed doorstop prevents the door from hitting the infrared heater. If the heater is installed behind a door, ensure that the door is closed during operation (to prevent heat accumulation).

The HEATSCOPE devices must not be used in rooms where there are people who cannot leave the room independently, unless these persons have constant supervision.

The devices are not intended for use by persons (including children) with reduced physical, sensory or mental abilities or lack of experience and/or knowledge, unless they are supervised by a person responsible for their safety or have received instruction from them on how to use the device.

2. Installation position in wet rooms

A 30 mA residual-current circuit breaker is mandatory for installation in wet rooms. The infrared heater may only be installed in safety zones 2 and 3 (see illustration).

During installation, ensure that the infrared heater or infrared towel rail cannot be operated or controlled from the bath or shower position. The thermostats must therefore be installed so that they cannot be reached from the bath or shower.

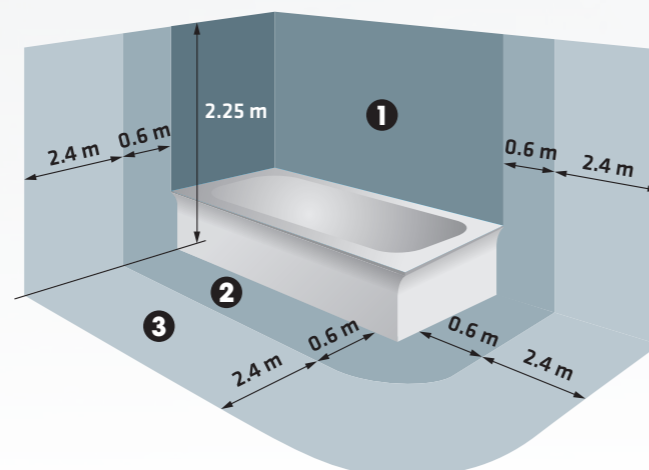

3. Control

If the devices are not fitted with an integrated control system, the regulation must be provided by an external thermostat controller that complies with the Ecodesign Directive.

4. Cleaning

Do not use any abrasive or aggressive cleaning agents to clean the infrared heater or infrared heated towel rail. We recommend cleaning with window cleaner or soapy water.

Caution

The infrared heater must have cooled down fully before cleaning. (Risk of damage due to cold shock)

5. Faults

The device does not heat up:
Please check the power supply.

If the device does not heat up but the power supply is in working order: Please send the device to your HEATSCOPE dealer for inspection.

Faulty or damaged power cable:
Faulty power cables must be replaced by the device manufacturer.

Caution

If the glass panel is damaged, stop using the heater and immediately disconnect it from the power.

Dear Customer,

In addition to the purchaser's entitlement to make statutory warranty claims against the seller, and without limiting this entitlement, HEATSCOPE grants the purchaser the right to make claims in accordance with the following warranty conditions for new devices:

I. Duration and start of the warranty

1. The warranty is granted for the following period:
 - a) 10 years for infrared heaters and infrared towel heater, when used as intended.
 - b) 2 years for products such as electronic controllers, thermostats and relays, when used as intended.
2. The warranty period starts from the date stated on the purchase invoice for the device. Warranty services and replacement parts provided under the warranty shall not prolong the warranty period.

II. Warranty conditions

1. The device was purchased through the authorised dealer or directly from HEATSCOPE in an EU country, Switzerland or Norway.
2. The proof of warranty (purchase invoice) is provided on request.

III. Content and scope of the warranty

1. Device defects are to be rectified free of charge within a reasonable period, with either repair or replacement of the relevant parts. HEATSCOPE will not cover the expenses associated with this, such as transport, travel, disassembly and installation costs. Parts or devices removed during replacement shall become the property of HEATSCOPE.
2. The warranty does not cover any other claims for damages against HEATSCOPE, unless there is wilful intent or gross negligence on the part of the approved customer service provider commissioned by HEATSCOPE.

IV. Limitations of warranty

The warranty does not cover defects or faults that are caused by:

1. Improper installation, e.g. failure to observe the applicable safety regulations or the written instructions for use, installation and mounting
2. Improper use or inappropriate operation or loads
3. External factors, such as transport damage, damage due to shock or impact, damage caused by weather or other natural phenomena
4. Repairs or modifications performed by customer service staff who have not been trained and approved for this service work by HEATSCOPE
5. Glass breakage
6. Current and voltage fluctuations that exceed or fall below the tolerance limits specified by the manufacturer
7. Non-compliance with maintenance and cleaning work as specified in the instructions for use

V. Data protection

Personal data is used only for the purposes of order processing and to deal with any matters relating to the warranty, and in compliance with general data protection regulations.

Packaging contents for:

- HEATSCOPE TUNE
- HEATSCOPE PULSE

Documents:

- Warranty
- Installation and mounting guidelines

Depending on the number of mounting holes:

Contents for 4-hole mounting

Contents for 6-hole mounting

Quantity Description		Quantity Description	
1	Infrared heater or infrared towel heater	1	Infrared heater or infrared towel heater
1	Cardboard drilling template	1	Cardboard drilling template
4	Multi-purpose plug MD8	6	Multi-purpose plug MD8
4	Neoprene washer M5	6	Neoprene washer M5
4	Hexagon head wood screw 5 x 50 mm	6	Hexagon head wood screw 5 x 50 mm

Materials required for installation:

- (not included in delivery)
- Spirit level
 - Metre stick
 - Pencil
 - Hammer drill
 - Concrete/masonry drill Ø 8 mm or wood drill Ø 4 mm
 - Hammer (to drive in the plugs)
 - Open-end or ratchet wrench, size 8 mm

TIP: Laser range finders and cross-line laser levels are useful when installing larger projects.

Plug applications

The supplied plugs are multi-purpose plugs and can be used for the following materials: concrete, solid blocks, brick, limestone, sandstone, autoclaved aerated concrete.

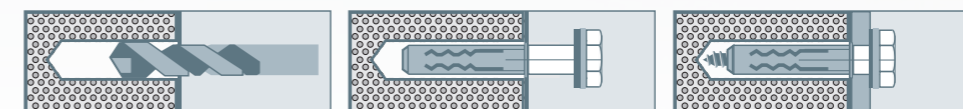

Installation instructions for mounting on walls or ceilings

HEATSCOPE®

- Check the contents of the packaging.
- Select the installation location (please read the installation and mounting guidelines carefully first).
- Use a spirit level or a metre stick to line up the cardboard drilling template on a level and clean surface.

TIP: Stick the cardboard drilling template to the wall with masking tape.

- The supplied cardboard drilling template is used for installing the HEATSCOPE devices.
- For installation on concrete, solid blocks, brick, limestone, sandstone or autoclaved aerated concrete, use a drill and the relevant 8 mm drill bit to drill a hole approx. 50 mm deep. Blow any residue out of the holes and insert the four (or six) supplied dowels into the holes.
- For safe attachment, above all on plasterboard walls and ceilings, it must be ensured that special connection technology is used and installed correctly in accordance with the load data. If necessary, consult an expert to ensure a professional solution.
- Please ensure that you have a level installation surface.

TIP: You can use a smaller drill bit to pre-drill the hole and make the drilling position more accurate.

- For installation on wood, use a drill and the relevant 4 mm drill bit to drill a hole approx. 50 mm deep.
- Put the Neoprene seals on the hexagon head wood screws 5 x 50 mm and screw these into the wall or ceiling until approx. 5 mm remains.
- Carefully mount the heating element.
- To secure the device during ceiling installation, now use pliers to rotate one pair of installation brackets by 180°.
- Use the 8 mm open-end or ratchet wrench to tighten the hexagon head screws.

TIP: Be sure to route the power cable according to the location of the socket or power connection.

Guide to symbols



International Commission on the Rules for the Approval of Electrical Equipment.



The safety mark S+ is a Swiss seal that manufacturers use to inform consumers that they comply with the Ordinance for Electrical Low-Voltage Products (NEV) and the legal regulations on electrical safety and electromagnetic compatibility.



Swiss Electrotechnical Association (SEV) mark for Swiss testing and certification body.



Warning icon for 'do not cover'. To prevent the heater from overheating, it must remain uncovered.

Any questions?
We'll gladly be
of service.



CHRISTIAN LUGE
International Sales,
Retail
T +49 8104 647 0915
cl@heatscope.com



SUSANNE BARTSCH
Retail, Restaurants,
Architects
T +49 8104 647 0923
sb@heatscope.com



MARTIN HEISS
Electrical Wholesale,
Electrical Engineering Firms
T +49 8930 904 090
mh@heatscope.com

HEATSCOPE®

MHS Munich Home Systems GmbH
Kramergasse 32 | D-82054 Sauerlach bei München
T +49 8104 647090 | mail@heatscope.com
www.heatscope.com